

PAGE[®]

ST 85 Systems

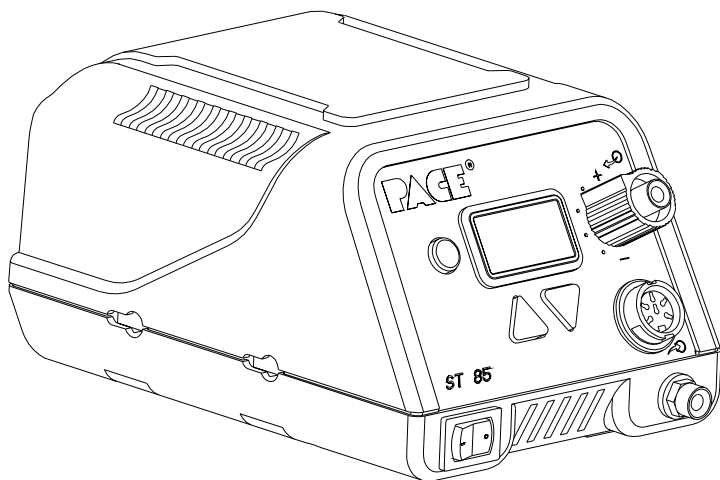

Operation & Maintenance Manual

PACE Incorporated retains the right to make changes to specifications contained herein at any time, without notice.

Contact your local authorized PACE Distributor or PACE Incorporated to obtain the latest specifications.

The following are registered trademarks and/or servicemarks of PACE Incorporated, Laurel Maryland U.S.A. and may only be used to identify genuine PACE products or services:

Arm-Evac, Flo-D-Sodr, Mini-Wave, PACE, SensaTemp, Snap-Vac, Sodrtrek, Sodr-X-Tractor, ThermoFlo, ThermoJet, ThermoTweez, Toolnet, Visifilter.

For any questions regarding this Operation & Maintenance Manual, contact your local authorized PACE distributor or contact PACE directly at the appropriate address listed below.

PACE USA 9893 Brewers Court
Laurel, Maryland 20723-1990
Tel.: (301) 490-9860
 (888) 535-7223 (PACE)
Fax (301) 498-3252

PACE EUROPE Sherbourne House, Sherbourne Drive
Tilbrook, Milton Keynes
MK7 8HX
United Kingdom
Tel.: (44)1908 277666
Fax: (44)1908 277777

or

www.paceworldwide.com

MANUAL NUMBER 5050-0455

REV. C

SYSTEM QUICKSTART

The ST 85 system is very easy to operate and can be quickly set up for use in standard desoldering/soldering operations.

To begin operation of your new system quickly, perform the "Set-Up" and "Quick Start - Basic Operation" procedures detailed on pages 13-19 of this manual. A shaded title bar on each of these pages highlight their location.

Table of Contents

<i>TITLE</i>	<i>PAGE</i>
General Information	4
Introduction	4
Specifications	4
Parts Identification	5
Safety	6
Safety Guidelines, English Language	6
Safety Guidelines, French Language	7
Safety Guidelines, German Language	8
Safety Guidelines, Italian Language	9
Safety Guidelines, Portuguese Language	10
Safety Guidelines, Spanish Language	11
Safety Guidelines, Swedish Language	12
Set-Up	13
Stacking	13
Tip & Tool Stand	13
Air Supply Connection	14
Handpiece Vacuum/Pressure	15
Handpiece Connection	17
System Power Up	17
Heater Burn In	17
Quick Start - Basic Operation	19
Introduction	19
Quick Start Procedure	19
Operation	20
Definitions	20
Password	21
Auto Tip Temperature Compensation	21
LED Display - Normal Operation	22
LED Display - Temperature Adjust Mode	23
Temperature Setback	24
Activation	24
Operation	24
Exiting Temperature Setback	25
Auto Off Safety System	25
Operation	25
Exiting Auto Off	25
Quick Tour	26
Factory Settings	28
LED Display Accuracy	28

Table of Contents

<i>TITLE</i>	<i>PAGE</i>
Set-Up Mode	29
Introduction	29
Entering Set-Up Mode	29
Operation	30
Password	30
Temperature Scale	30
Temperature Limits	31
Offset Constant	32
Temperature Setback	32
Auto Off	33
Temperature Display Impedance	33
Exiting Set-Up Mode	33
Corrective Maintenance	34
LED Display Message Codes	34
Power Source	35
Handpieces	36
Packing List/Spare Parts	37
Packing List	37
Spare Parts	37
Limited Warranty Registration Form	38

<i>TABLE</i>	<i>PAGE</i>
Table 1 Factory Settings	28
Table 2 LED Display Message Codes	34
Table 3 Power Source Corrective Maintenance	35
Table 4 Heater Assembly Checkout Procedures	36
Table 5 Packing List	37
Table 6 Spare Parts	37

General Information

Introduction

Thank you for purchasing the PACE model ST 85 Digital Desoldering/Soldering System. This manual will provide you with the information necessary to properly set up, operate and maintain the ST 85 system.

The ST 85 systems are available in either the 115 VAC, or 230 VAC version which incorporates a highly responsive SensaTemp (closed loop) control system providing up to 80 Watts of total power to a single output channel. The 230 VAC version system bears the CE Conformity Marking which assures the user that it conforms to all the requirements of council directive EMC 89/336/EEC. The systems package the power source with a selection of accessories and functional aids.

The 115 VAC version system conforms to all the requirements of FCC Emission Control Standard, Title 47, Subpart B, Class A. This system has been tested and found to comply with the limits for a Class A digital device, pursuant to part 15 of FCC rules. These limits are designed to provide reasonable protection against harmful interference when the equipment is operated in a commercial environment. This equipment generates, uses, and can radiate radio frequency energy and, if not installed and used in accordance with this manual, may cause harmful interference to radio communications. Operation of this equipment in a residential area is likely to cause interference in which case the user will be required to correct the interference at his own expense.

Specifications

System Power Source Power Requirements

ST 85 - Operates on 97-127 VAC, 50/60Hz, 90 Watts maximum
at 115 VAC, 60Hz

ST 85E - Operates on 197-253 VAC 50/60Hz, 80 Watts maximum
at 230 VAC, 50Hz

Shop Air Input Requirements:

Pressure - 5.48 Bar (80 p.s.i.) recommended
6.17 Bar (90 p.s.i.) maximum

Air Flow - 45.3 SLPM (1.6 SCFM) minimum

Temperature Specifications

Handpieces

Tip Temperature Range: 204 to 482°C (400 to 900°F) nominal.

Temperature Stability: $\pm 1.1^{\circ}\text{C}$ ($\pm 2^{\circ}\text{F}$) at idle from set tip temp.

NOTE - Actual minimum and maximum Operating Tip Temperatures may vary depending on Handpiece, Tip Selection and application.

EOS/ESD Specifications

The specifications shown below apply except on "Soft Ground Systems" which have a 1 meg ohm current limiting resistance and a label placed on the power source front panel referring to EN 100015-1.

Tip-To-Ground Resistance: Less than 2 ohms.

AC Leakage: Less than 2 millivolts RMS from 50Hz to 10MHz.

Transient Level: Less than 500mV peak, out to 100MHz.

Parts Identification

① Power Receptacle

② Power Switch

③ LED Display

④ Program Key

⑤ Scroll Up Key

⑥ Scroll Down Key

⑦ Vacuum Port

⑧ Controllable Pressure Port

⑨ AC Power Receptacle/Fuse Holder

⑩ Fuse

□□ Air Fitting

□ Earth Ground Receptacle
(230 VAC systems only)

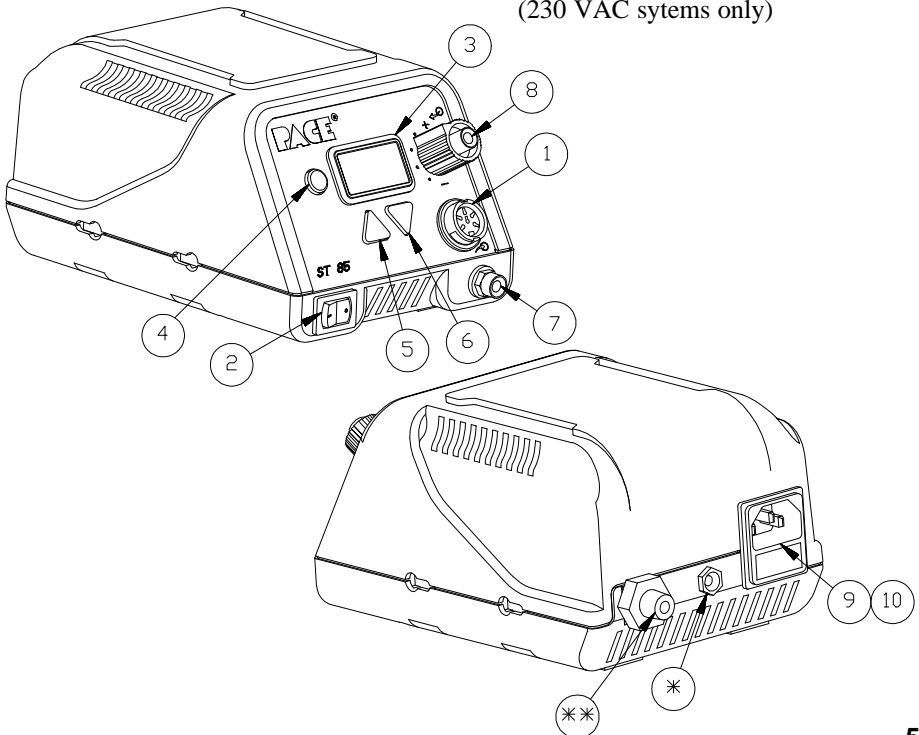

Safety

Safety Guidelines - English Language

The following are safety precautions which personnel must understand and follow when using or servicing PACE products.

1. **POTENTIAL SHOCK HAZARD** - Repair procedures on PACE products should be performed by Qualified Service Personnel only. Line voltage parts may be exposed when the equipment is disassembled. Service personnel must avoid contact with these parts when troubleshooting the product.
2. To prevent personnel injury, adhere to safety guidelines in accordance with OSHA and other applicable safety standards.
3. SensaTemp handpiece heaters and installed tips are hot when the handpiece is powered on. **DO NOT** touch either the heater or the tip. Severe burns may result.
4. PACE Tip & Tool Stands and handpiece cubbies are designed specifically for use with the associated handpiece and houses it in a manner which protects the user from accidental burns. Always store the handpiece in its holder. Be sure to place the handpiece in its holder after use and allow to cool before storing.
5. Always use PACE systems in a well ventilated area. A fume extraction system such as those available from PACE are highly recommended to help protect personnel from solder flux fumes.
6. Exercise proper precautions when using chemicals (e.g., solder paste). Refer to the Material Safety Data Sheet (MSDS) supplied with each chemical and adhere to all safety precautions recommended by the manufacturer.

Directives de Sécurité, Française Langue

Les précautions suivantes, sont celles que le personnel doit comprendre et suivre lorsqu'il utilise, effectue la maintenance ou se sert d'un produit PACE.

1. **Danger potentiel de choc électrique** - Les procédures de réparation sur les produits PACE doivent être effectuées seulement par du personnel qualifié. Des parties de l'équipement désassemblées peuvent être sous tension. Le personnel de maintenance doit éviter tout contact avec ces parties en réparant le produit.
2. Pour prévenir tout préjudice, le personnel adhère au guide de sécurité en accord avec OSHA (équivalent à des normes françaises de sécurité) et d'autres standards de sécurité applicable.
3. La mise sous tension des outils SensaTemp comporte des éléments chauffants (buse). Ces derniers, gardent la chaleur même après la mise hors tension pendant un certain temps. **Ne pas** toucher les parties chaudes aux extrémités des outils. Des brûlures sévères peuvent en résulter.
4. Les outils PACE et leurs panes ainsi que le support sont dessinés de manière spécifique afin de protéger l'utilisateur/opérateur de brûlures accidentelles. Reposer toujours les outils après chaque utilisation dans leurs étuis/supports afin de permettre leur refroidissement.
5. Utiliser toujours les stations Pace dans un lieu bien ventilé. Des extracteurs de fumée Pace sont hautement recommandés pour protéger votre personnel des vapeurs de soudure/flux.
6. Prenez les mesures nécessaires quand vous utilisez des produits (ex: solder paste) chimiques. Reportez-vous au document (fiche technique/sécurité) du fabricant fourni avec chaque produit. Respectez toutes les procédures de sécurité recommandées par le constructeur.

Sicherheit Korrekturlinien, Deutsche Sprache

Die nachfolgenden Sicherheitsvorschriften sollten vom Bedien- un Servicepersonal verstanden und befolgt werden.

1. **Entladung spannungsfuehrender Teile** - Reparaturen an PACE Produkten sollten nur von qualifizierten Personal durchgefuehrt werden. Spannungsfuehrende Teile koennen sich bei gezogenen Netzstecker entladen. Servicepersonal muss den Kontakt dieser Teile vermeiden.
2. Um moegliche Gefahren fuer Personen auszuschliessen, muessen alle Sicherheitsvorschriften in Uebereinstimmung mit OSHA und anderen anwendbaren Sicherheitsstandards eingehalten werden.
3. Angeschlossene SensaTemp Heizelemente von Handwerkzeugen und installierte Loetspitzen sind heiss wenn das System eingeschaltet ist oder erst vor kurzer Zeit ausgeschaltet wurde. Heizelement und Loetspitze nicht beruehren. Verbrennungsgefahr.
4. PACE Tip & Tool und andere Handwerkzeugablagen sind so konstruiert, dass ein versehentliches Beruehren des dazugehoerendes Handwerkzeuges vermieden wird. Bewahren Sie das Handwerkzeug nach Gebrauch stets in der Ablage auf. Bevor das Handwerkzeug an einem anderen Ort gelagert werden muss, lassen Sie es in der Werkzeugablage vollstaendig abkuehlen.
5. Benutze PACE Systeme nur in gut beluefteten Raeumen. Ein Loetrauchabsaugsystem, wie es z.B. von PACE erhaeltlich ist, hilft Bedienpersonen von den Gefahren von Loetrauch zu schuetzen.
6. Wenn Chemikalien (z.B.: Lotpaste) verwendet werden, muessen alle die in den Sicherheitsdatenblaettern des Herstellers ausgewiesenen Sicherheitsvorschriften eingehalten werden.

Misure di Sicurezza, Italiana Lingua

Le seguenti istruzioni sono misure di sicurezza che il personale deve comprendere e seguire quando utilizza o ripara I prodotti PACE.

1. **EVENTUALIRISCHIDISHOCKELETTTRICO**-Si consiglia di far eseguire le operazioni di riparazione dei prodotti PACE, da un servizio di personale qualificato. Quando la stazione non é assemblata le parti sottoposte alla tensione di linea potrebbero essere scoperte. Il personale deve evitare il contatto con queste parti durante manutenzione del prodotto.
2. Per evitare eventuali pericoli al personale, attenersi alle norme di sicurezza previste dalla guida, in conformità all'OSHA e agli altri Standard di Sicurezza applicabili.
3. Le resistenze PACE Sensatemp e le punte installate sono calde quando la stazione é accesa e per un periodo successivo allo spegnimento. Non toccare la resistenza e la punta. Può comportare gravi ustioni.
4. I supporti PACE sono specificamente costruiti insieme alla corrispondente impugnatura e progettati per un uso che protegge gli utenti da ustioni accidentali. Mettere sempre l'impugnatura nel proprio supporto dopo l'utilizzo e lasciarla raffreddare prima di riporla.
5. Utilizzare sempre I stazioni PACE in una zona be aerata per proteggere il personale dai fumi. É fortemente raccomandato un sistema di aspirazione (dei fumi) come quello disposta dalla PACE.
6. Usare precauzioni quando si utilizzano sotanze chimiche (es. Pasta di stagno). Fare riferimento al Material Safety Data Sheet (MSDS) fornita con ogni sostanza chimica e seguire tutte le misure di sicurezza raccomandate dal fabbricante.

Guidelines de Segurança, Portuguese Lingua

Segeum-se precauções de segurança que os operadores devem compreender e seguir ao utilizar ou reparar produtos PACE.

1. **Perigo de choque eléctrico** - Os procedimentos de reparação em produtos PACE, devem ser apenas efectuados por pessoal qualificado. Linhas de alimentação podem ficar expostas ao desmontar o equipamento. Pessoal de reparação deve evitar o contacto com essas partes ao reparar o produto.
2. Para evitar danos pessoais, siga as normas de segurança OSHA ou outras normas aplicáveis.
3. Resistencias de aquecimento dos ferros e as pontas instaladas estão quentes quando o ferro está alimentado, e mesmo durante algum tempo após ser desligado. **NUNCA TOCAR** nem na resistencia de aquecimento nem na ponta. Pode resultar em queimaduras severas.
4. Os suportes para pontas e ferros da PACE, foram concebidos para uso específico, e para proteger o operador de queimaduras acidentais. Coloque sempre os ferros nos respectivos suportes. Tenha a certeza de colocar sempre o ferro no respectivo suporte após cada utilização e deixe-o arrefecer antes de o guardar.
5. Utilize sempre os sistemas da PACE em locais bem ventilados. Um Sistema de extracção de fumos, como os Sistemas disponíveis na PACE, são altamente recomendados para a protecção dos utilizadores contra os fumos produzidos pela solda e fluxo.
6. Tenha precauções apropriadas ao utilizar produtos quimicos (ex. pasta de soldar). Lêr sempre atentamente os normas de segurança fornecidas com cada produto químico e siga sempre todas as precauções de segurança recomendadas pelo fabricante.

Guías de Consulta de Seguridad, Español Lenguaje

Lo siguiente es precauciones de seguridad que el personal debe entender y debe seguir al usar o reparar productos de PACE.

1. **RIESGO de SHOCK POTENCIAL**- Los procedimientos de la Reparación en productos de PACE sólo deben ser realizados por Personal de Servicio Calificado. Pueden exponerse partes de voltaje de línea cuando el equipo se desmonta. El personal de servicio debe evitar contacto con estas partes al arreglar el producto.
2. Para prevenir lesión del personal, adhiera a las reglas de seguridad de acuerdo con OSHA y otras normas de seguridad aplicables.
3. Las herramientas SensaTemp tienen sus calentadores y las puntas instaladas calientes cuando la herramienta esta encendida y por un periodo de tiempo después de apagar el equipo. **No toque el calentador o la punta.** Las quemaduras severas pueden resultar.
4. El Soporte de punta y Herramienta PACE se diseñan específicamente para el uso con las herramientas asociadas y las almacena de una manera que protege al usuario de las quemaduras accidentales. Siempre guarde la herramienta en su soporte. Esté seguro de poner la herramienta en su soporte después del uso y permita que la herramienta enfríe antes de guardar.
5. Siempre use sistemas de PACE en una área bien ventilada. Un sistema de extracción de humo como esos disponibles de PACE se recomiendan para ayudar a proteger al personal contra los humos de flujo de soldadura.
6. Ejercice las precauciones apropiadas al usar químicos (ej., pasta de la soldadura). Refiérase a la Hoja de Datos de Seguridad de Material (MSDS) proporcionado con cada químico y adhiere a todas las precauciones de seguridad recomendadas por el fabricante.

Säkerhetsföreskrifter

Säkerhetsföreskrifter, Svenska

Följande säkerhetsföreskrifter måste förstås och följas av personal som använder eller utför service på PACE produkter.

1. **RISK FÖR STRÖMSTÖT** - Service / Reparation av PACE produkter får endast utföras av aktoriserad service personal. Strömförande delar kan komma åt när produkten är isärplockad. Iakttag aksamhet när felsökning görs för att undvika strömstötar.
2. För att undvika personskada rekommenderas att OSHA eller andra liknande arbets säkerhets standarder följs.
3. SensaTemp verktygselement och installerade spetsar är heta när strömmen är påslagen och en tid efter att strömmen slagits av. **RÖR EJ** element eller spets. Risk för brännskador!
4. PACE Spets och Verktygshållare är speciellt utformade för att passa PACE respektive verktyg så att risken för brännskador kan undvikas. När verktyget ej används bör det alltid förvaras i sin hållare.
5. Tillse att ventilationen är god där PACE System används. Ett lödröksutsug system som t.ex. PACE tillhandahåller rekommenderas för att skydda användaren för giftig lödrök.
6. Tillse att gällande säkerhetsföreskrifter följs vid användning av kemikalier, t.ex. lodpasta. Se säkerhetsdatabladerna som medföljer kemikalierna och följ de rekommenderade säkerhetsföreskrifterna från respektive tillverkare.

Set-up

Set up the ST 85 system using the following steps and associated drawings.

1. Store the shipping container(s) in a convenient location. Reuse of these containers will prevent damage if you store or ship the system.
2. Place the Power Switch in the “OFF” or “0” position.

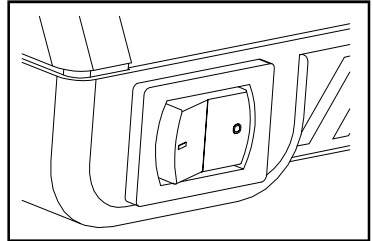

Stacking

ST 25, 45, 65 & 85 systems can be stacked one on top of the other (up to 3 units high). Ensure that the power sources are positioned as shown with the recessed area in the bottom of the top power source placed over the raised portion on top of the bottom power source.

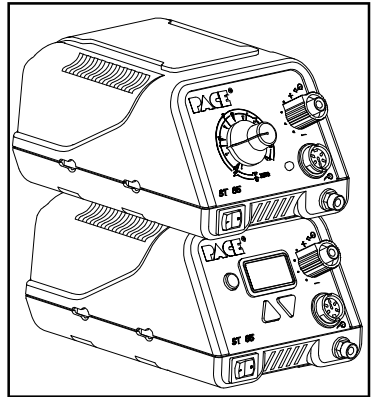

Set-Up

Tip & Tool Stand

If you have purchased a system with a handpiece, set up the Tip & Tool Stand in the following manner. If you have purchased another SensaTemp handpiece, use the instructions enclosed with the handpiece and associated Tip & Tool Stand.

1. To attach the stand to the power source, use the following procedure.

- a) Insert the 2 Mounting Screws (head first) into the 2 power source mounting slots shown. Slide the screws toward rear of power source.
- b) Place the Tip & Tool Stand beside the power source. Insert ends of the 2 Mounting Screws into the 2 Tip & Tool Stand mounting holes shown.
- c) Install a Thumb Nut onto the end of each Mounting Screw. Tighten Thumb Nuts to secure the stand in position.

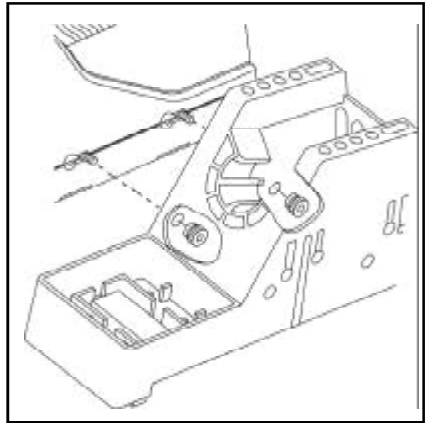

2. Place the handpiece into its Tip & Tool Stand.

Air Supply Connection

The ST 85 system utilizes an integral air venturi system to provide air pressure and vacuum for any connected PACE SensaTemp air handpiece. Your in-house air supply (regulated to 5.48 Bar (80 P.S.I.); see "Specifications") must be connected to the system power source.

CAUTION

The system must be connected to a clean, dry, and filtered air supply regulated to 5.48 Bar (80 P.S.I.); see "Specifications". Connection to a contaminated air supply or one with pressure in excess of 6.16 Bar (90 p.s.i. may cause damage to the power source.

1. Attach a length of Small, Flexible Air Hose (not supplied) to the Air Hose Fitting on the rear of the PACE power source using the following procedure.
PACE does not recommend the attachment of quick connect air hose fittings to the power source. The weight of the standard large air hose lines will affect the stability of the system and would require a larger bench space.
 - a) **230 VAC Systems only:** A metric adapter fitting (PACE part number 1259-0081) is included for use with 230 VAC systems.

NOTE

DO NOT overtighten connections. Damage to the system could occur if excessive torque is applied to the Air Hose Fitting, metric adapter or Connector.

- b) Install the Connector (with Small, Flexible Air Hose) onto the Air Hose Fitting (or metric adapter) finger tight. Using an appropriate wrench, tighten the Connector an additional 1/4 turn. **DO NOT** overtighten.
2. Connect the free end of the small, flexible air line to your air supply using the appropriate fittings.

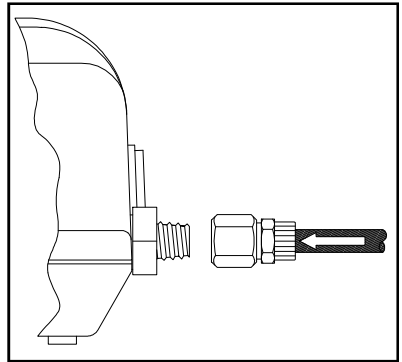

Handpiece Vacuum/Pressure

To set up your Sodr-X-Tractor air hose connection, perform the following steps:

1. Air Hose To Handpiece Connection

- a) Attach one end of a 137cm (54 inch) length of air hose to the metal tube in the back of the handpiece.
- b) If you have a PACE system incorporating only one handpiece, attach the air hose to the power cable using the supplied Hose Clamps. Space them evenly along the length of the power cable starting at a point 6 inches from the ends of the handpiece.
- c) If you have a PACE system incorporating 2 or more air handpieces, you may wish to leave the air hose assembly unattached to allow a quick change to any air handpiece being used.

Set-Up

2. Prepare a VisiFilter in the following manner:
 - a) Connect a 1 inch (2.5cm) length of clear pvc air hose to the FLOW OUT side of the VisiFilter; push and turn the hose onto the VisiFilter nipple to seat.
 - b) Insert the ribbed end of a male quick connect hose mount fitting (P/N 1259-0087) into the free end of the 1 inch (2.5cm) length of air hose connected to the FLOW OUT side of the VisiFilter.
 - c) Connect the free end of the 137cm (54 inch) length of air hose to the FLOW IN side of the VisiFilter.
 - d) Insert the end of the quick connect hose mount fitting (on VisiFilter FLOW OUT side) into the power source Vacuum Port.

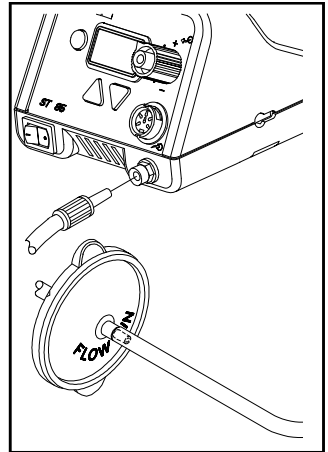

3. When using air pressure, and/or utilizing multiple air handpieces, PACE recommends the use of the following set up procedure which utilizes additional quick connect hose mount fittings. An assortment of quick connect air fittings are supplied with each additional air handpiece.
 - a) Disconnect the 137cm (54 inch) length of air hose from the FLOW IN side of the VisiFilter assembly. Insert the ribbed end of a male quick connect hose mount fitting (P/N 1259-0087) into the free end of this air hose.
 - b) Connect the free end of a 1 inch (2.5cm) length of air hose with an installed female quick connect hose mount fitting (P/N 1259-0086) to the FLOW IN side of the VisiFilter Assembly.
 - c) The 137cm (54 inch) length of air hose can now be easily moved between the VisiFilter Assembly and the Controllable Pressure Port. The VisiFilter assembly remains connected to the Vacuum Port.
4. Additional fittings may also be added to the hose connection at the rear of each air handpiece to ease changing of handpieces.

NOTE

When removing any air hose, turn and pull. Do not attempt to pull hose directly off. Damage to or breakage of fitting or VisiFilter may occur. Use your Sodr-X-Tractor with a clean VisiFilter element. Otherwise a deterioration in performance or damage to the unit may occur.

Handpiece Connection

Connect the handpiece connector plug into the Power Receptacle in the following manner.

1. Align guide on connector with slot on power receptacle.
2. Insert connector into power receptacle.
3. Turn the connector housing clockwise to lock in place.

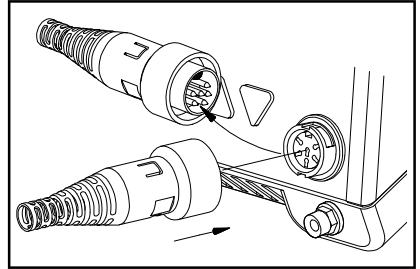

System Power Up

1. Insert the female end of the power cord into the AC Power Receptacle at the rear panel of the power source.
2. Plug the prong end (male end) of the power cord into a 3 wire grounded AC supply receptacle. The system is now ready for operation.

CAUTION

To ensure operator safety, the AC supply receptacle must be checked for proper grounding before initial operation.

3. Read this manual and all other included manuals thoroughly before operating the system.

Set-Up

Heater Burn In

To ensure optimum performance and long life, new TJ-70 handpieces must undergo a burn in procedure. A Red tag is attached to each handpiece and with replacement heater assemblies which describes the proper procedure. The ST 85 system however, has a Burn In feature which, when activated will burn in the TJ-70 heater in a similar manner as is described on the tag. Use this feature when setting up a new ST 85 system or when replacing a TJ-70 handpiece heater assembly.

NOTE

Ensure that the system is placed in a well-ventilated area. Smoke will be emitted from the heater assembly during the burn in cycle.

Use the following instructions to perform the Heater Burn In procedure.

1. Place the Power Switch in the “OFF” (0) position.
2. Ensure that the handpiece is connected to the system power source. Some handpieces heater assemblies are shipped with a plastic cap installed on the end of the heater assembly. If this cap is present, remove the cap and discard. The cap is used for shipping purposes only.

3. Press and hold the Program () and Scroll Up (▲) keys together.

4. Place Power Switch in “ON” (I) position.

5. Release the Program () and Scroll Up (▲) keys. The Display will read “brn”.

6. Press the Scroll Up (▲) Key to enter the Burn In Mode. The handpiece heater will begin to heat up with the temperature displayed (in °C or °F). The heater temperature will stabilize at 315°C (or 600 °F) and remain at that temperature for 10 minutes.

7. At the conclusion of the 10 minute period, the heater temperature will increase to 427°C (or 800°F) and remain at that temperature for 15 minutes.

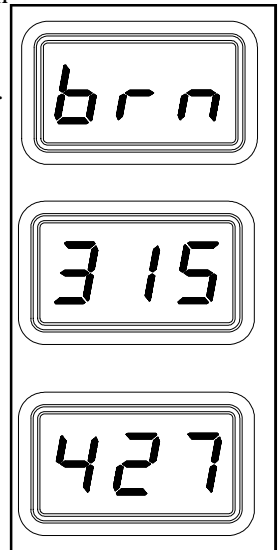

- At the conclusion of the 15 minute time period, power is removed from the heater. The Display will read "End". Press and release the Scroll Up Key (▲) to exit Heater Burn In and return the to normal operation.

NOTE

The microprocessor circuitry within the unit monitors the system to ensure proper results. If any abnormalities are encountered, the Burn In cycle will be interrupted and an error message displayed. If this situation should occur, turn the system off and perform the procedure again. If the cycle is interrupted a second time, refer to Table IV and check for handpiece malfunction. If a second handpiece is available, perform the procedure using that handpiece.

Quick Start - Basic Operation

Introduction

The ST 85 system is very easy to operate. As received from the factory, the system can be quickly set up for use in standard desoldering/soldering operations. Simply perform the following Quick Start Procedure to begin system operation.

Quick Start Procedure

1. Ensure that the Set-Up procedure has been performed; including the Heater Burn In procedure. Check for the following:
 - a) Handpiece connections (connector plug and air hose) to the power source.
 - b) Proper tip installed in handpiece.
 - c) Power cord connection between house AC supply receptacle and the power source.
 - d) House air supply connection to power supply.

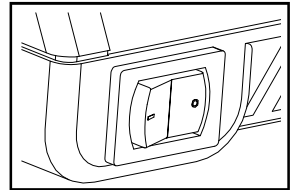

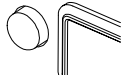
2. Turn the Power Switch “On” (“I”).
3. Press the Scroll Up (▲) Key to enter the Temperature Adjust Mode.
4. Press the Scroll Up (▲) Key to increase the desired Tip Temperature. Press the Scroll Down (▼) Key to decrease the desired Tip Temperature.
5. Press the Program Key (). The system will now return to normal operation.
6. Observe the Digital Readout as the temperature stabilizes at the desired Set Tip Temperature.
7. If you have a Sodr-X-Tractor or other PACE air handpiece connected to your system, press and hold the Vacuum Switch to check for proper operation. You will hear a clicking noise as the air is turned on in the system. An audible sound of air movement will be present. Release the Vacuum Switch.

NOTE

Read the “Operation” and “Set-Up Mode” sections of this manual to utilize the full capabilities of the system. This is especially important when using large soldering tips or other SensaTemp handpieces.

Operation

IMPORTANT

PACE recommends that you not read the “Set-Up Mode” section until after you feel comfortable with system operation. Please read the following “Operation” section thoroughly before changing the system settings.

Definitions

Please read and become familiar with the definitions of each of the following terms which are used repeatedly in the following operational procedures.

AUTO OFF - Safety feature which turns power off (10-90 minutes, settable in 10 minute increments) after the system has entered Temperature Setback.

NORMAL OPERATION - Normal operating mode of the system in which the Operating Tip Temperature is displayed.

OPERATING TIP TEMPERATURE - The true tip temperature at which the handpiece tip operates at any given time.

SET TIP TEMPERATURE - The operator selected idle tip temperature entered into the system memory.

SET-UP MODE - Mode of operation in which the operator can quickly and easily adjust the system parameters (e.g., temperature limits, password, setback time).

TEMPERATURE ADJUST MODE - Mode of operation in which the operator can quickly and easily adjust the Set Tip Temperature.

TEMPERATURE DISPLAY IMPEDANCE (TDI) MODE - Stabilizes the tip temperature shown on the LED Display by ignoring minor temperature fluctuations. Displayed changes in temperature are delayed (impeded) for two seconds when a load is applied to the tip. Two seconds after the load is removed, the displayed temperature will begin rising to set temperature. Particularly useful in a production environment for monitoring of set temperatures, since under most production circumstances the temperature will not deviate.

TEMPERATURE SETBACK - System feature which, when enabled, will independently set back the Set Tip Temperature to 177°C (350°F) after a user selected period of handpiece inactivity (10 to 90 minutes, settable in 10 minute increments). This feature is enabled (or disabled) in the Set-Up Mode.

TIP OFFSET CONSTANT - Specific value for a given handpiece/tip combination upon which the system automatically calculates the correct Tip Temperature Offset at any entered Set Tip Temperature. This value is the temperature loss (Tip Temperature Offset) at 371°C (700°F) and is set in the Set-Up Mode. A value of 0-115°C (0-240°F) may be entered in the Set-Up Mode.

TIP TEMPERATURE OFFSET - Difference in value between the temperature measured by the temperature sensor (at the heater) and the true temperature of the tip at a given Set Tip Temperature.

NOTE

As with any system, Set and Operating Tip Temperatures are only exactly equal when the handpiece is idling (unloaded at equilibrium). During use, (i.e., under load) the Operating Tip Temperature will usually be lower.

Password

The Password feature of the ST 85 system, when activated, will prevent unauthorized alteration of stored system temperature parameters and feature settings (refer to Table I, “Factory Settings”). If a Password has been installed, the LED Display will display an instruction to enter the Password (a 5 key sequence of the keys on the system front panel) when a setting change is attempted.

Once the correct Password has been entered, the operator can proceed to make the desired setting changes. To reactivate the Password protection, simply turn the system Power Switch off and then back on. The system is now in normal operation. Refer to the “Set-Up Mode” section of this manual for instructions on entering, changing or removing a Password.

Auto Tip Temperature Compensation

Differences between the temperature settings and true tip temperatures are negligible when using Thru-Hole, single point desoldering tips. With any heating system however, True Tip Temperatures can differ greatly from temperature settings when using larger SMT soldering tips. This difference is called Tip Temperature Offset. The ST 85 Auto Tip Temperature Compensation feature lets you set and display true tip temperatures regardless of size and type of tip or handpiece. PACE recommends the use of the Tip & Temperature Selection System booklet (PACE P/N 5050-0251) as a guide to accurately set and maintain a true tip temperature for any size and type of SMT tip. The booklet contains a listing of PACE tip information including the Tip Offset Constant (for each tip) which must be stored in system memory to ensure tip temperature accuracy. Refer to the “Set-Up Mode” section of this manual for instructions on using this feature.

Operation

The ST 85 system is very easy to adjust and operate. The following instructions detail system features and operation of the system. Also included is a "Quick Tour" of system operation.

Information regarding changing of system options (e.g., Temperature Setback time, Auto Off) is contained in the "Set-Up Mode" portion of this manual.

LED Display, Normal Operation

The LED Display provides a 3 digit display of temperature information. The LED Display will show:

1. A display of "888" on initial power up to ensure that all LEDs on the display are working.
2. A display of the the software version of the installed microprocessor (e.g., "1-1") for 2 seconds on initial power up after the "888" is displayed.
3. Actual tip temperature of the connected handpiece during normal operation.
- 4 The tip temperature displayed will flash when the system is in Temperature Setback.
5. The displayed temperature will decrease and stabilize at 177°C (350°F) when the system is in Temperature Setback.

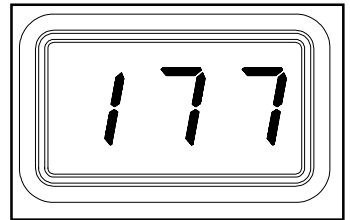
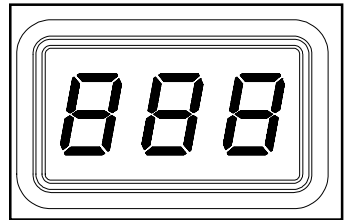

6. "OFF" when the Set Tip Temperature has been set to Off (below minimum set tip temperature). Refer to the "Set-Up Mode" portion of this manual.
7. "OFF" plus the LED Display will be flashing when the unit has entered Auto Off. Refer to the "Set-Up Mode" portion of this manual.

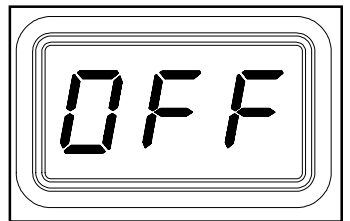

- 8 Error messages ("OSE", "SSE" or "OCE") if a system fault is detected. Refer to the "Corrective Maintenance" portion of this manual.

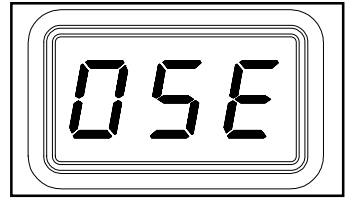

LED Display, Temperature Adjust Mode

The LED Display will show the following when adjusting the desired Set Tip Temperature.

1. The Set Tip Temperature.
2. "HiL" (High Temperature Limit) when adjusting the set tip temperature and the maximum allowable temperature is exceeded. Refer to the "Set-Up Mode" portion of this manual.
3. "OFF" (Low Temperature Limit) when adjusting the set tip temperature and the minimum allowable temperature is exceeded. Refer to the "Set-Up Mode" portion of this manual.
4. "EP0" will be displayed if a Set Tip Temperature adjustment is attempted and a Password has been stored in system memory. As the 5 key Password is entered, the zero will increase by one as each key entry is made. Upon entry of the fifth password key, the display will change to the Set Tip Temperature if the entered Password matches the stored Password.
5. "no" will be displayed if the entered password does not match the stored Password.

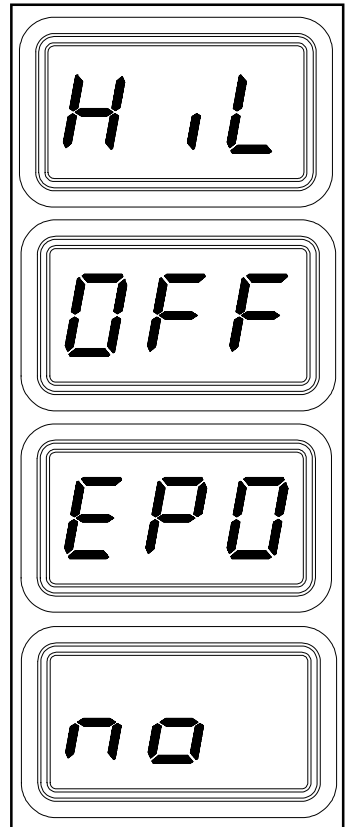

Operation

Temperature Setback

To preserve tip life and save energy, the ST 85 system can be programmed to automatically set back its Tip Temperature to 177°C (350°F) after a selected period of handpiece inactivity (adjustable 10-90 minutes in Set-Up Mode). As received from the factory, this feature is enabled. Refer to the “Set-Up Mode” section of this manual to disable or adjust the time-out period of this feature. The operator can also force the system into Temperature Setback.

Activation

There are two ways in which the system will activate the Temperature Setback feature.

1. **Automatic Activation** - The system memory can be programmed so that the system will automatically activate Temperature Setback after a selected period (10-90 minutes) of handpiece inactivity. See the “Set-Up Mode” section for details on programming this feature.
2. **Manual Activation** - The operator can manually force the system to place the system in Temperature Setback by performing the following procedure.
 - a) Press and hold the Scroll Down (▼) Key.
 - b) Press the Scroll Up (▲) Key.
 - c) Release both keys.

Operation

Temperature Setback is indicated by the following.

1. The LED display will be flashing.
2. The Operating Temperature will stabilize at 177°C (350°F).

Exiting Temperature Setback

Listed below are 3 different ways to exit Temperature Setback.

1. Press and release either Scroll Key (▲ or ▼). This is the preferred method.
2. Wipe the hot handpiece tip on a wet sponge to lower the tip temperature.
3. Method “1” is preferred but you can turn the Power Switch “OFF” (“0”) and then back “ON” (“1”).

Set Tip Temperature and Tip Offset Constant values will be simultaneously restored. Observe the LED Display as the Operating Tip Temperature stabilizes at the Set Tip Temperature. For optimum performance, do not attempt to use the attached handpiece until the Set Tip Temperature is achieved.

Auto Off Safety System

When enabled, the Auto Off safety system of the ST 85 system removes power 10-90 minutes (enabled/disabled and adjustable in Set-Up Mode) after entering Temperature Setback.

Operation

When the system has entered Temperature SetBack, an Auto Off timer within the system circuitry will start running (if Auto Off is turned on in Set-Up Mode):

1. If any key is pressed during the selected time out period, the Auto Off timer is reset. The system will return to normal operation.
2. At the end of the time out period, the system will enter Auto Off. Power is removed, the LED Display will show “OFF” and the display will be flashing.

Exiting Auto Off

Auto Off can be exited; returning to normal operation by:

1. Pressing and releasing a Key (either of the 3 keys).

OR

2. By turning the Power Switch OFF (“0”) and then back ON (“1”).

Operation

Quick Tour

1. Ensure that the Set-Up procedure has been performed; including the Heater Burn In procedure. Check for the following:
 - a) Handpiece connection to the power source.
 - b) Proper tip installed in handpiece.
 - c) Power cord connection between house AC supply receptacle and the power source.
2. Turn the Power Switch "On" ("I").
3. Press the Scroll Up (▲) Key. The Set Temperature is now displayed. If no other Key is pressed within 5 seconds, the system will revert to normal operation. Allow time for the system to change back.
4. Press the Scroll Up (▲) Key. The Set Temperature is now displayed; immediately perform step 5.
5. Adjust the Set Temperature in the following manner:
 - a) Press and release the Scroll Up (▲) Key to increase Tip Temperature in increments. Press and release the Scroll Down (▼) Key to decrease Tip Temperature. Observe the display as the Set Temperature increases in increments of 1°.



NOTE

If a Password has been previously programmed into the system, "EP0" will be appear on the LED Display at this point. When this message appears, the operator must enter the correct 5 key Password before adjusting the temperature. Refer to "Password" in the "Operation" portion of this manual.

- b) Adjust the temperature by pressing and holding Scroll Up (▲) Key. Observe the display as the Set Temperature increases first in increments of 1° and then in increments of 10°. Release the key.
- c) Using the Scroll Keys, adjust the temperature to any standard operating temperature used by your company.

NOTE

The Set Temperature can only be within the set temperature limits. If a limit (upper or lower) is reached, the lower limit would display "OFF"; the upper limit would not allow the Set Temperature to exceed that limit. Temperature limits can be adjusted in the Set-Up Mode.

6. Press the Program Key ( ). The system will now return to normal operation.
7. Observe the Digital Readout as the temperature stabilizes at the desired Set Tip Temperature
8. Manually force the system into Temperature Setback in the following manner:
 - a) Press and hold the Scroll Down (▼) Key and the Scroll Up (▲) Key.
 - b) Release both keys.
9. The system is now in Temperature Setback. Observe the flashing of the LED Display and the decreasing of the tip temperature. Allow time for the temperature to stabilize at 177°C (350°F).

NOTE

If Auto Off has been enabled (turned on in Set-Up Mode), the system will enter Auto Off (temperature Off and LED Display flashing "Off") after the preset time of handpiece inactivity. Auto Off can be exited by pressing any key.

10. Manually force the system out of Temperature Setback in either of the following manners:
 - a) Press and release a Key (either of the 3 keys). This is the preferred method.
 - b) Wipe the hot handpiece tip on a wet sponge to lower the tip temperature.
 - c) Turn the Power Switch Off ("0") and then back on ("I").
11. The system is now in normal operation. Observe the LED Display as the tip temperature increases to the Set Temperature. Allow time for the temperature to stabilize at the Set Temperature.

NOTE

Read the "Operation" and "Set-Up Mode" sections of this manual to utilize the full capabilities of the system. This is especially important when using large soldering tips or other SensaTemp handpieces.

12. If you have a Sodr-X-Tractor or other PACE air handpiece connected to your system, press and hold the Vacuum Switch. You will hear a clicking noise as the air is turned on in the system. An audible sound of air movement will be present. Release the Vacuum Switch.

Operation

FACTORY SETTINGS

The ST 85 system comes equipped with a number of features which may be adjusted, enabled or disabled as desired by the user. Listed below are the features and factory settings of each. To change and/or learn about any of these features, refer to the applicable part of the “Set-Up Mode” portion of this manual.

FEATURE	FACTORY SETTING
Password	None Entered
Default Temperature Scale (°C/°F)	°F for 115V Systems °C for 230V Systems
"HI" (upper) Temperature Limit	482°C (900°F)
"LO" (lower) Temperature Limit	204°C (400°F)
Set Temperature	"OFF"
Tip Offset Constant	"0"
Temperature Setback	Enabled
Setback Time	30 Minutes
Auto Off	Enabled
Time To Auto Off	30 Minutes

Table 1. Factory Settings

LED Display Accuracy

No adjustments are necessary to maintain the accuracy of the system.

Introduction

The menu driven LED Display of the ST 85 system in the Set-Up Mode allows you to easily customize your system. No calibration adjustments are necessary to maintain the accuracy of the system.

In Set-Up Mode, you can:

1. Enter, remove or change a Password.
2. Set the Default Temperature scale to °F or °C as desired.
3. Change the Upper and Lower Temperature limits.
4. Enter a Temperature Offset Constant (Auto Tip Temperature Compensation).
5. Enable or disable the Temperature Setback feature and adjust the time-out period (if enabled).
6. Enable or disable the Auto Off feature and adjust the time-out period (if enabled).
7. Enable or disable the Average Temperature feature.

The following instructions should be performed to familiarize the operator with the system.

Entering Set-Up Mode

1. Place Power Switch in the "OFF" ("0") position.

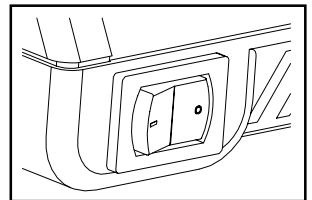

2. Press and hold the Program Key ().

3. Place Power Switch in the "ON" ("1") position. Release the Program Key

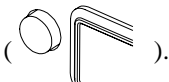



Set-Up Mode

Operation

Password

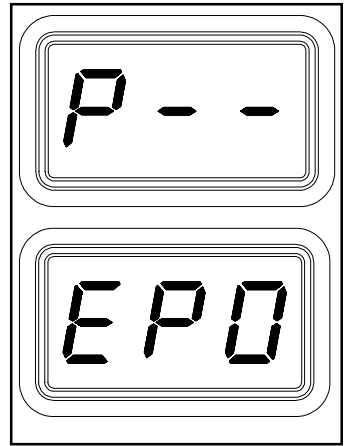
- The LED Display will display the version of the microprocessor and change to read "P--" or "EP0".
- If the display reads "EP0", a Password has been stored in system memory. Enter the 5 key sequence Password. If the Password entered is incorrect, "no" appears on the display and the system then returns to normal operation. If this occurs, repeat steps 1 through 5 and enter the correct Password.
- The LED Display reads "P_ _". Choose one of the following options:



- Press the Program Key () to keep the currently stored Password (including no Password).
 - Press and release the Scroll Up (▲) Key to enter a new Password.
 - Press and release the Scroll Down (▼) Key if you wish to remove a stored password or do not wish to store a Password.
- If the LED Display now reads "EP0", select and enter a 5 key password sequence. Make a note of the entered Password. As the Password is entered, the last digit of the display will count up with each key entry. After the fifth key entry, proceed to step 8.

Temperature Scale

- The LED Display now shows the stored default Temperature Scale (°C or °F temperature shown on LED Display). Choose one of the following:

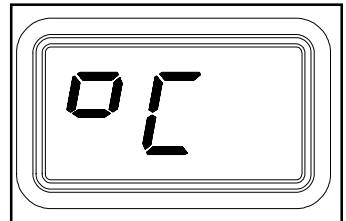

- Press the Program Key () to keep the stored default Temperature Scale.
- Press and release the Scroll Up (▲) Key to change the default Temperature Scale. Press and release the Program Key.

Temperature Limits

9. The LED Display now shows the stored default High ("Hi") Temperature Limit with the display alternating to show "Hi" and the stored limit. Choose one of the following:

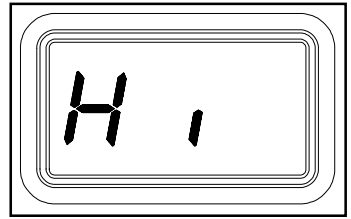

- a) Press and release the Program Key () to keep the stored High Temperature Limit.
- b) Press and release the Scroll Up (▲) Key to increase the stored High Temperature Limit (up to 482°C, 900°F). Press and release the Program Key to proceed to the next step.
- b) Press and release the Scroll Down (▼) Key to decrease the stored High Temperature Limit. Press and release the Program Key to proceed to the next step.

10. The LED Display now shows the stored default Low ("Lo") Temperature Limit with the display alternating to show "Lo" and the stored limit. Choose one of the following:

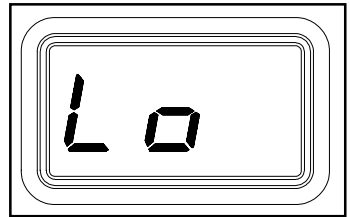



- a) Press and release the Program Key () to keep the stored Low Temperature Limit (204°C, 400°F).
- b) Press and release the Scroll Up (▲) Key to increase the stored Low Temperature Limit. Press and release the Program Key to proceed to the next step.
- c) Press and release the Scroll Down (▼) Key to decrease the stored Low Temperature Limit. Press and release the Program Key to proceed to the next step.

Set-Up Mode

Offset Constant

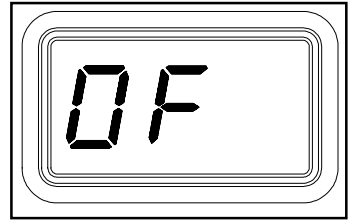
11. The LED Display now shows the stored Offset Constant with the display alternating to show "OF" and the stored Offset Constant. Choose one of the following:



- a) Press and release the Program Key () to keep the currently stored Offset Constant.
- b) Press and release the Scroll Up (▲) Key to increase the stored Offset Constant. An Offset Constant of 0-133°C (0-240°F) can be stored. Press and release the Program Key to proceed to the next step.
- c) Press and release the Scroll Down (▼) Key to decrease the stored Offset Constant. Press and release the Program Key to proceed to the next step.

NOTE

If the attached handpiece is disconnected when the system is powered up, any stored Offset Constant is reset to zero. The Offset Constant must be entered again in the Set-Up Mode.

Temperature Setback

12. The LED Display now shows the stored Temperature Setback time as "S-X" (x=0 thru 9). Time is shown as tens of minutes (e.g., "S-3" equals 30 minutes). A display of "S-0" indicates that Setback is disabled. Choose one of the following:

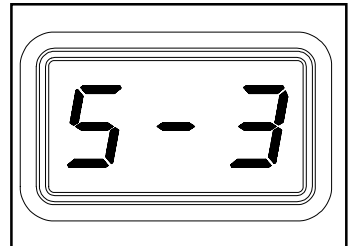

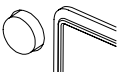
- a) Press and release the Program Key () to keep the currently stored Temperature Setback time.
- b) Press and release the Scroll Up (▲) Key to enable and/or increase the stored Temperature Setback time. Press and release the Program Key to proceed to the next step.
- c) Press and release the Scroll Down (▼) Key to decrease or disable the stored Temperature Setback time. Press and release the Program Key to proceed to the next step.

Auto Off

13. The LED Display now shows the stored Auto Off time as "AOx" (x=0 thru 9). Time is shown as tens of minutes (e.g., "AO3" equals 30 minutes). A display of "AO0" indicates that Auto Off is disabled. Choose one of the following:

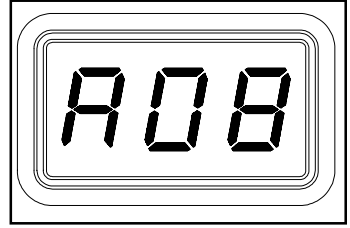

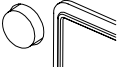
- Press and release the Program Key () to keep the currently stored Auto Off time.
- Press and release the Scroll Up (▲) Key to enable and/or increase the Auto Off. Press and release the Program Key to proceed to the next step.
- Press and release the Scroll Down (▼) Key to decrease or disable the stored Auto Off time. Press and release the Program Key to proceed to the next step.

Temperature Display Impedance

14. The LED Display now shows the Temperature Display Impedance mode as Enabled or Disabled ("AC0" = Disabled and "AC1" = Enabled). Choose one of the following:

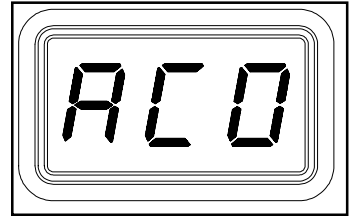

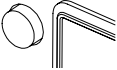
- Press and release the Program Key () to keep the currently stored setting (Disabled or Enabled).
- Press and release the Scroll Up (▲) Key to change the stored setting (Disabled or Enabled). Press and release the Program Key to proceed to the next step.

Exiting Set-Up Mode

15. The LED Display now reads "End". The Set-Up Mode procedure is now complete. Choose one of the following steps:

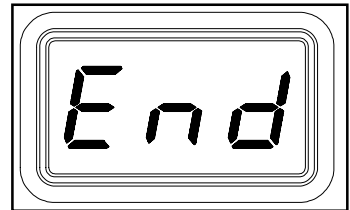

- Press and release the Scroll Up (▲) Key to exit Set-Up Mode and return to normal operation.
- Press and release the Scroll Down (▼) Key to return to the start of the Set-Up Mode procedure. Go back to step 4.

Corrective Maintenance

LED Display Message Codes

Listed below are message codes which may be shown on the LED Display if a mistake is made by the operator (e.g., wrong Password entry) or if the system has malfunctioned.





LED Display Message	Description
	<p>The incorrect Password has been entered. The displayed message will time out after 6 seconds and revert to normal operation. Enter the correct Password.</p>
 The LED Display is flashing.	<p>No handpiece is connected to the Power Receptacle. Connect handpiece.</p> <p>The handpiece heater assembly sensor is open. Refer to Table 4 to check handpiece.</p>
 The LED Display is flashing.	<p>The handpiece heater assembly sensor is shorted. Refer to Table 4 to check handpiece.</p>
 The LED Display is flashing.	<p>The handpiece heater assembly may be defective. Refer to Table 4 to check handpiece.</p> <p>Power source malfunction. Call the PACETechnical Support for assistance. Tel. 1-888-535-7223 (toll-free), FAX 1-301-483-7030.</p>

Table 2. LED Display Message Codes

Power Source

Most malfunctions are simple and easy to correct. Refer to Table 3.

Symptom	Probable Cause	Solution
No power to system.	Blown Fuse	Check handpiece using Table 2. Replace the fuse (located in the AC Receptacle/Fuse Holder) with one of same value (see Table 4, Spare Parts).
No heat on handpiece.	Defective Heater	See Table 2.
No vacuum or air pressure at handpiece.	House air supply not connected.	Check house air supply connection to power source.
	Kinks in handpiece	Remove kinks or replace air hose.

Table 3. Power Source Corrective Maintenance

Handpieces

The following “Heater Assembly Checkout Procedures” (Table 4) is applicable to all PACE SensaTemp handpieces used with the ST 85 system except for the TT-65 and DTP-80 handpieces. Refer to the applicable manuals for troubleshooting procedures pertinent to that handpiece.

Perform the procedures with the handpiece heater at room temperature. If the heater is warm, resistance readings will be different from those shown. Disconnect the handpiece from the power source. Use a meter to check resistance across the handpiece connector plug pins as outlined in the “Checkout Procedure” column.

Symptom	Checkout Procedure	Cause	Solution
Handpiece does not heat.	Check resistance - Pin 2 to Pin 5. Refer to "Heater Specifications" column. If resistance is high - -	Open Heater	Replace Heater Assembly.
	Check resistance - Pin 3 to Pin 6. If circuit reads open - -	Open Sensor	Replace Heater Assembly.
Handpiece overheating.	Check resistance - Pin 3 to Pin 6. Resistance should be 110 ohms. If resistance is less than 105 ohms - -	Shorted Sensor	Replace Heater Assembly.
Fuse blows when unit is turned on.	Check resistance - Pin 2 to Pin 5. Refer to "Heater Specifications" column. If resistance is low - -	Shorted Heater	Replace Heater Assembly & Fuse.
No Ground on Tip.	Check resistance - Pin 4 to a NEW Tip. Resistance should be less than 2 ohms. If not - -	Oxidation in Heater Bore.	Clean Heater Bore using appropriate wire brush.
		Defective Heater	Replace Heater Assembly.

Heater Specifications	
PS-80 = 8 - 10 ohms SX-80 = 8 - 10 ohms SX-70 = 8 - 10 ohms TP-65 = 9 - 11 ohms TJ-70 = 6 - 8 ohms	 <p>Connector Plug Pinouts</p>

Table 4. Heater Assembly Checkout Procedures

Packing List/Spare Parts

Packing List

This is a packing list of the items shipped with the system and is current at the time of publication of this manual.

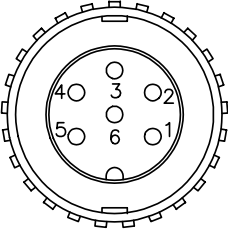
PACKING LIST			Quantity Supplied			
			ST 85 Systems		ST 85-SX80 Systems	
Item #	Description	Part Number	ST 85	ST 85E	ST 85	ST 85E
1	ST 85 System Power Source	-----	1	1	1	1
2	SX-80 Handpiece, (48 Watts)	6010-0106	0	0	1	1
3	Power Supply Cord, 115 VAC	1332-0094	1	0	1	0
4	Power Supply Cord, 230 VAC	1332-0093	0	1	0	1
5	Tip & Tool Stand Kit	6019-0060-P1	0	0	1	1
6	SX-80 Accessory Kit	-----	0	0	1	1
7	Tip Tool	1100-0206	1	1	1	1
8	Air Fitting Adaptor	1259-0081	0	1	0	1
9	Operation & Maintenance Manual	5050-0455	1	1	1	1

Table 5. Packing List

Spare Parts

Item #	Description	Part Number
1	Fuse, 1.0 Amp Time Lag (ST 85)	1159-0246
	0.5 Amp Time Lag (ST 85E)	1159-0213
2	SX-80 Heater Assembly	6010-0107-P1
3	Replacement PCB Assembly	6020-0127-P1
4	Tip & Temperature Selection System Booklet	5050-0251

Table 6. Spare Parts

LIMITED WARRANTY

PACE warrants that this equipment will be free of defects in materials and workmanship for a period of one (1) year from the date of receipt by the first user.

This warranty does not cover repair or replacement required as a result of misuse, mishandling or improper storage. Failure to perform recommended routine maintenance, alterations or repairs made other than in accordance with PACE's directions, or removal or alteration of identification plates in any way will void this warranty. This warranty is available only to the first user, but the exclusions and limitations therein apply to all persons and entities.

This warranty does not apply to consumable items, such as tips, filter elements, hoses, collection chambers etc., except that heaters are normally warranted for a period of six (6) months from the date of receipt by the first user.

PACE MAKES NO OTHER WARRANTY, EXPRESSED OR IMPLIED, AND MAKES NO WARRANTY OF MERCHANTABILITY OR FITNESS FOR A PARTICULAR PURPOSE

PACE will, at its option, repair or replace any defective equipment or parts at its facility or other location approved by it at no charge to the user; or provide parts without charge for installation by the user in the field at user's expense and risk. User will be responsible for all costs of shipping equipment to PACE or other warranty location for warranty service.

EXCEPT FOR THE REMEDY ABOVE DESCRIBED, UNLESS OTHERWISE REQUIRED BY APPLICABLE LAW, PACE WILL HAVE NO OTHER OBLIGATION WITH REGARD TO ANY BREACH OF WARRANTY OR OTHER CLAIM WITH RESPECT TO THE EQUIPMENT, OR LIABILITY FOR ANY DIRECT, INDIRECT, CONSEQUENTIAL, OR INCIDENTAL LOSS OR DAMAGE CAUSED BY OR OCCURRING IN CONNECTION WITH ANY OF THE EQUIPMENT.

To obtain warranty service, contact the appropriate PACE company listed below

PACE Inc. 9893 Brewers Court, Laurel, Maryland 20723-1990
Tel. (888) 535-7223 (toll-free) Warranty Service FAX 301 483 7030

PACE Europe Ltd. Sherbourne House Sherbourne Drive Tilbrook Milton Keynes
United Kingdom MK7 8HX
Tel. (44) 01908 277 666 Warranty Service FAX (44) 01908 277 777

Do NOT return defective equipment or parts to PACE without obtaining prior authorization.

Any warranty or other claim with respect to the equipment must be made in writing and delivered to PACE (or local authorized PACE Distributor outside the U.S.) within a reasonable time of the expiration date of this warranty. Sufficient evidence of purchase and date of receipt must also be included, otherwise user's rights under this warranty shall be deemed waived.